

Dunlop Aircraft Tyres Limited  
40 Fort Parkway  
Erdington  
Birmingham B24 9HL  
England

Telephone 44(0) 121 384 8800  
Facsimile 44(0) 121 377 7150  
Sita techsupport@dunlopatl.co.uk  
e-mail enquiries@dunlopatl.co.uk  
web site www.dunlopairecrafttyres.com



**GENERAL PRACTICES MANUAL  
For  
AIRCRAFT TYRES AND TUBES  
DM1172**

**STATEMENT OF INITIAL CERTIFICATION**

This manual complies with British Civil Airworthiness Requirements, Section A, Chapter A5-3

Signed:

A handwritten signature in black ink, appearing to be 'M. J. ...', written over a horizontal line.

Date: January 25<sup>th</sup> 2008

E.A.S.A. Approval No.: 21J.207

**NOTE:** The above certification does not apply to revisions or amendments made after the date of initial certification by other Approved Organisations. Revisions or amendments made by other Approved Organisations must each be separately certified, and recorded on separate record sheets.

©2008 Dunlop Aircraft Tyres Limited. All Reproduction Rights Reserved

**DM1172**

PRINTED IN ENGLAND

RECORD OF PERMANENT REVISIONS

(Incorporated under E.A.S.A. Approval No.: 21J.207)

Retain this record at the front of the Manual. On receipt of Revision, revise as detailed in the Letter of Transmittal and record the incorporation of the revision on this sheet. The introduction of data by revisions or amendments not certified in accordance with British Civil Airworthiness Requirements, Chapter A5-3, will invalidate the initial certification on the title page of the manual relative to the part revised. Revisions or amendments embodied in this manual and certified by an appropriate approved Organisation other than that applicable to the initial certification must be recorded on separate record sheets.

Rev. No.	Issue Date	Date Inserted	By

LIST OF EFFECTIVE PAGES

<u>SUBJECT</u>	<u>PAGE</u>	<u>DATE</u>	<u>SUBJECT</u>	<u>PAGE</u>	<u>DATE</u>
Title Page	-	2002/05/31	Maintenance Practices for Tyres Installed on Aircraft	301	2002/05/31
Record of Revisions	1	2002/05/31		302	2002/05/31
	2	Blank		303	2002/05/31
List of Effective Pages	1	2002/05/31		304	2002/05/31
	2	Blank		305	2002/05/31
Table of Contents	1	2002/05/31		306	2002/05/31
	2	2002/05/31		307	2002/05/31
	3	2002/05/31		308	2002/05/31
	4	2002/05/31		309	2002/05/31
Introduction	1	2002/05/31		310	2002/05/31
	2	Blank		311	2002/05/31
General Tyre Information	1	2002/05/31		312	2002/05/31
	2	2002/05/31		313	2002/05/31
	3	2002/05/31		314	2002/05/31
	4	2002/05/31		315	2002/05/31
	5	2002/05/31		316	2002/05/31
	6	2002/05/31		317	2002/05/31
	7	2002/05/31		318	Blank
	8	2002/05/31			
	9	2002/05/31			
	10	2002/05/31			
Receiving Instructions/ Storage	101	2002/05/31			
	102	2002/05/31			
Installation and Removal of Tyres	201	2002/05/31			
	202	2002/05/31			
	203	2002/05/31			
	204	2002/05/31			

TABLE OF CONTENTS

	<u>PAGE</u>
<u>INTRODUCTION</u>	1
<u>GENERAL TYRE INFORMATION</u>	1
<u>Introduction</u>	1
<u>Tyre Markings</u>	1
Introduction	
Tyre Size	
Speed Rating	
Ply Rating (PR) and Load Rating	
FAA Specification TSO C62	
Serial Number	
AEA Code	
Dunlop Part Number	
Military Tyre Markings	
Vent Hole Marking	
Balance Point Marking	
Retread Markings	
Tube Markings	
<u>Tyre Construction</u>	6
Introduction	
Tread	
Inter-Tread Fabric	
Casing	
Breakers	
Beads	
Chafers	
Sidewall	
Inner Liner	
Chined Tyres	
Breaker Package (Radial-Ply Tyres Only)	
Casing (Radial-Ply Tyres Only)	
<u>RECEIVING INSTRUCTIONS AND STORAGE</u>	101
<u>Introduction</u>	101
<u>Instructions to Receive Tyres and Tubes</u>	101
Tyres	
Tubes	

<u>Storage</u>	101
Storage Conditions	
Storage Instructions	
Storage of Tyres Installed on Wheel Assemblies	
Shelf Life	
<u>INSTALLATION AND REMOVAL OF TYRES</u>	201
<u>General</u>	201
<u>Tyre Installation</u>	201
Installation of a Tubeless Tyre	
Installation of a Tubed Tyre	
<u>Tyre Inflation</u>	202
Initial Checks	
Inflation	
Checks for Loss of Pressure	
Diffusion from Awl Vent Holes	
<u>Tyre Deflation and Removal</u>	204
Tyre Deflation	
Tyre Removal	
<u>MAINTENANCE PRACTICES (FOR TYRES INSTALLED ON AIRCRAFT)</u>	301
<u>General</u>	301
<u>Inflation Pressure Maintenance</u>	301
Inflation Pressure Checks	
Pressure Checks at Ambient Temperature	
Inflation Pressures	
Recommended Tyre Pressure Maintenance	
Pressure Maintenance of Hot Tyres	
Pressure Maintenance with Changes of Ambient Temperature	
<u>Tyre Inspection (Wear Limits)</u>	306
Introduction	
Retreadable Tyre	
Non Retreadable Tyre	
Tyre with Nylon Fabric Included	
Tyre in Very Wet Operational Conditions	
Multi-dimple Tyre	
Twin-contact Tyre	

<u>Tyre Inspection (Damage Limits and Tyre Failures)</u>	307
Introduction	
Chevron Cutting	
Tread Chunking	
Cut Damage	
Dry Braking Flats	
Wet Braking Flats	
Bulges (Tyre Failure)	
Shoulder Wear	
Burst (Tyre Failure)	
Lateral Scoring	
Sidewall Cracking	
Tread Groove Cracking	
High Brake Heat	
Open Tread Joint	
<u>Procedure After a Rejected Take-Off (RTO)</u>	315
<u>Flat Spots</u>	315
<u>Contamination</u>	316
<u>Uneven Wear</u>	316
<u>Tube Inspection (Damage Limits)</u>	316
Tube Chafing (Related to Tyre Creep)	
Tube Creasing	
Tube Cracking	

TABLES

	<u>TABLE</u>
Recommended Tyre Pressure Tolerances	301
Recommended Tyre Pressure Maintenance	302

ILLUSTRATIONS

	<u>FIGURE</u>
Examples of Tyre Markings	1
Dimensions Used for Tyre Size Specification	2
Bias (Cross-Ply) Tyre	3
Radial-Ply Tyre	4
Chevron Cutting	301
Tread Chunking	302
Cut Damage	303
Dry Braking Flats	304
Wet Braking Flats	305
Bulge	306
Shoulder Wear	307
Burst (Tyre Failure)	308
Lateral Scoring	309
Sidewall Cracking	310
Tread Groove Cracking	311
High Brake Heat	312
Open Tread Joint	313
Tube Chafing	314
Tube Creasing	315
Tube Cracking	316

INTRODUCTION

1. General

- A. This manual includes general maintenance and servicing procedures applicable to aircraft tyres which Dunlop Aircraft Tyres Limited (DATL) make and supply. The information is applicable to bias (cross-ply) tyres (which can be tubeless or have inner tubes), and to radial-ply tyres and tubes.
- B. Use the instructions in this manual, or use other instructions as specified (for example, instructions in an Aircraft Maintenance Manual (AMM), a Component Maintenance Manual (CMM) for the aircraft wheel, a Technical Order, or an Airworthiness Directive).

NOTE: The Sections of this manual are in Page Blocks 1, 100, 200 and 300.  
Page Block 1 is pages 1, 2, 3 etc., Page Block 100 is pages 101, 102, 103 etc.,  
Page Block 200 is pages 201, 202, 203 etc., Page Block 300 is pages 301, 302,  
303 etc.

- C. If more information is necessary, speak to a representative of DATL, or to a person in the Technical Department of DATL at the address below.

Dunlop Aircraft Tyres Limited  
40 Fort Parkway  
Erdington  
Birmingham  
B24 9HL  
England

Telephone 44(0) 121 384 8800  
Facsimile 44(0) 121 377 7150  
Sita BHXDLCR  
e-mail enquiries@dunlopatl.co.uk  
Web site www.dunlopaircrafttyres.com



GENERAL TYRE INFORMATION

1. Introduction

A. This Section (Page Block 1) includes information about tyre markings (Ref. Para. 2.) and tyre construction (Ref. Para. 3.).

2. Tyre Markings (Ref. Fig. 1)

A. Introduction

- (1) Fig. 1 is an example of the tyre markings moulded into the rubber of a Dunlop aircraft tyre. These markings could include: the tyre size, the speed rating, an FAA specification, a serial number, an AEA code, a Dunlop part number, special markings for military tyres, vent hole markings, balance point marking, and retread markings.

GENERAL PRACTICES MANUAL  
AIRCRAFT TYRES AND TUBES

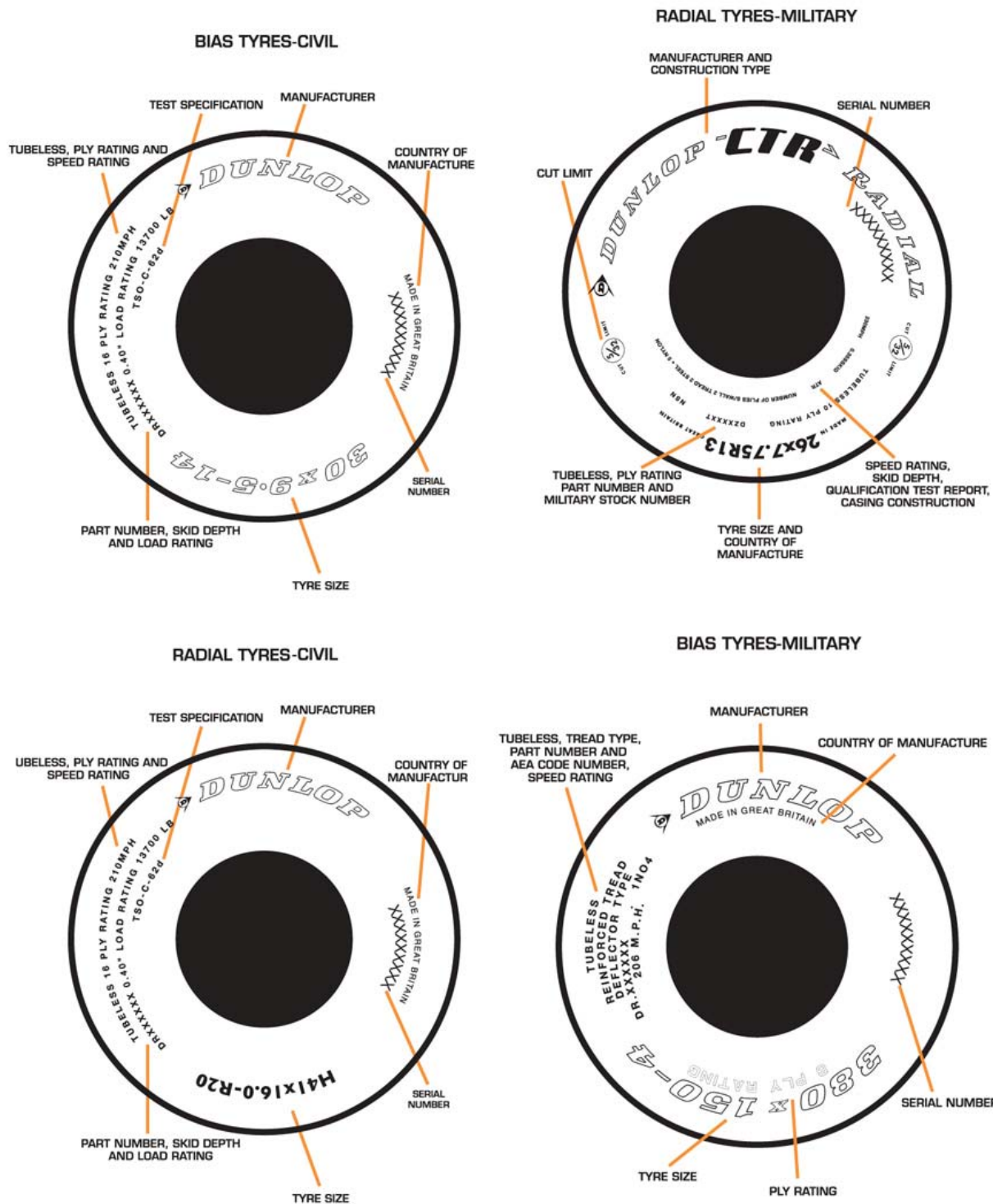

Examples of Tyre Markings  
Figure 1

B. Tyre Size (Ref. Fig. 2)

(1) A tyre size could be shown on a tyre as follows:

- (a) A only (for example, 44"), or
- (b) B-C only (for example, 8.50-10), or
- (c) AxB only (for example, 49x17), or
- (d) AxB-C (for example, 49x19.0-20) or
- (e) AxBRC (for example, 46x17R20) for radial-ply tyres.

**NOTE:** The size specifications shown in Para 2.B.(1)(d) and (e) above are the standards now used for tyres of new design.

- (2) A tyre size could have a prefix H (for example, H49x19.0-22). The H tells you that the wheel rim on which the tyre is to be installed must have a specified width between its flanges (in the range 0.60 to 0.70 x the nominal width of the tyre).
- (3) Dimensions A, B and C could be inches or millimeters. For example, for a tyre size specified as 750x230-15, dimension A = 750 mm, dimension B = 230 mm, and dimension C = 15 in.
- (4) An inner tube size is specified the same as the size of its related tyre.

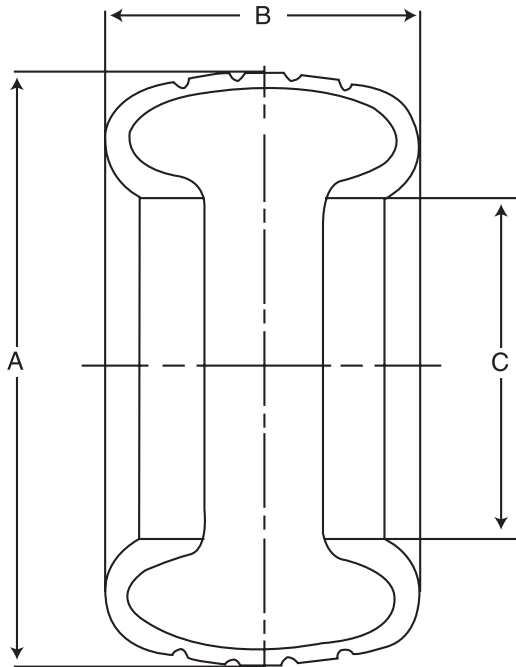

Dimensions Used for Tyre Size Specification  
Figure 2

**C. Speed Rating**

- (1) The speed rating of a tyre (for example, 225 mph) is its maximum rated ground speed (approved after completion of tests on the tyre at that speed).

**D. Ply Rating (PR) and Load Rating**

- (1) The ply rating (for example, 22 PR) is an index which can identify the maximum rated static load that can be applied to the tyre (when it is inflated to a specified pressure and is used in specified conditions of operation).
- (2) The load rating is the maximum static working load that is permitted.

**E. FAA Specification TSO C62**

- (1) This is a specification of the Federal Aviation Agency (FAA) for the minimum qualification test of aircraft tyres.

**F. Serial Number**

- (1) Each Dunlop tyre has a different serial number which includes the date of manufacture. For example, in the serial number 99001236:
  - (a) 99 is the year of manufacture.
  - (b) 001 is the day of manufacture (the first day of the year).
  - (c) 236 identifies the tyre.

**G. AEA Code**

- (1) For the Association of European Airlines (AEA) it is necessary to show an AEA code. This code identifies the number of casing plies (carcass and breaker plies) and the modification status of the tyre design. For example in the AEA code N018-2A:
  - (a) N018 is the number of carcass plies.
  - (b) -2 is the number of breaker plies.
  - (c) A is the tread modification number.

**H. Dunlop Part Number**

- (1) Dunlop part numbers are four or five digit numbers with a prefix of two or three letters. If used, a suffix T shows that a tyre is tubeless. For example, a Dunlop part number could be shown as DR15348T.
- (2) The prefix of two or three letters is used to show specified characteristics of a tyre, as follows:
  - (a) DR - a bias tyre with a rib tread.

- (b) DRR - a tyre with fabric in the tread for more strength (the second R = reinforced).
- (c) DZ - a radial-ply tyre.
- (d) DA - an anti-shimming tyre or a twin-contact tyre.
- (e) DB - a tyre with a serrated rib.

(3) The prefix DT is used for the part number of an inner tube.

#### J. Military Tyre Markings

- (1) Tyres for military aircraft have special markings related to the military specification. These markings could include a stores identification number (for example a NATO Stock Number).

#### K. Vent Hole Marking

- (1) Vent holes are small holes (awl holes) made in the lower sidewall of the tyre and above the wheel flange area.
- (2) On a tubeless tyre, green litho ink or paint is used to show the positions of the vent holes. The hole depth is only to the middle section of the casing. The holes are for the release of the small quantity of inflation gas which can diffuse through the inner liner. Without the vent holes the diffused gas could cause ply or tread separation.
- (3) On tyres for which an inner tube is necessary, grey or silver litho ink or paint is used to show the positions of the vent holes. These vent holes are fully through the tyre casing, and are for the release of diffused inflation gas caught between the tube and the inner wall of the tyre. Also, the holes release the air that is trapped in the casing during tyre manufacture.

#### L. Balance Point Marking

- (1) The balance mark on a tyre is a red spot or a red triangle which identifies the 'light' point.
- (2) When you install a tubeless tyre, use the applicable instructions in the manufacturer's Component Maintenance Manual (CMM) for the related wheel. If there are no maintenance instructions related to the wheel (or no other special instructions), align the red balance mark of the tyre with the inflation valve on the wheel.
- (3) The balance mark for an inner tube is a red stripe which identifies the 'heavy' point. This is usually adjacent to the valve stem of the tube. When you install an inner tube, align the balance marks of the tube and the tyre. If an inner tube has no balance mark, align the valve stem of the tube with the balance mark of the tyre.

**M. Retread Markings**

- (1) A Dunlop retreaded tyre has a number of markings added in a retread panel on the sidewall. The markings could include: the identity of the airline, the date of the retread, the retread stage, the AEA tread identification code and the mould skid depth. For example, retread panel markings could be as follows:
  - (a) BA (Airline Name).
  - (b) K10012;S/N90123456 (Retread Reference; Serial Number).
  - (c) DR 23635T (Part Number).
  - (d) TSOC62d; -22PR; -30100LBS (FAA Qualification; Ply Rating; Load Rating).
  - (e) DR2 04/92 (Retread Stage and Month/Year of retread).
  - (f) 225 MPH (Speed Rating).
  - (g) AEA F2B; 0.42 SKID (Tread Identification Code; Mould Skid Depth).
- (2) More information on a retreaded tyre is shown on the tread buttress. For example, this could include: the tyre size, AEA code, country of retread and the tread pattern identity.

**N. Tube Markings**

- (1) The markings on a Dunlop tube could include:
  - (a) A date code (for example, JUN 99), or
  - (b) A day of the week/week of the year/year code (for example, 2/11/99).
  - (c) Manufacturer.
  - (d) Part No.
  - (e) Issue No.
  - (f) Stores ID No.
  - (g) Other markings.

**3. Tyre Construction (Ref. Fig. 3,4)****A. Introduction**

- (1) Fig. 3 shows a cross-ply (bias) tyre. Fig. 4 shows the different construction of a radial-ply tyre. Almost all of the tyre construction information (Ref. Para. 3.B. thru 3.K.) is applicable to the two types of tyre. Para. 3.L. and 3.M. are applicable to radial-ply tyres only.

**B. Tread**

- (1) The tread is a special rubber compound which is resistant to abrasive wear, cutting, chunking and heat. Around its circumference the tread has moulded grooves which:
  - (a) Help to remove water between the tread and the runway during wet conditions, and
  - (b) Increase the traction and the grip.

**C. Inter-Tread Fabric**

- (1) An aircraft tyre can include inter-tread fabric (ITF) (also known as tread reinforcement layers). This is one or more layers of nylon fabric between the casing plies and the base of the tread. The ITF keeps the tread stable and free from distortion during high speeds when there is increased centrifugal force. The ITF also gives protection to the casing plies if debris cuts the tread. For tyres which can be retreaded, the ITF can be used as a wear indicator.
- (2) For special high speed applications, the ITF can be moulded into the rubber of the tread. As the tyre wears, the ITF is seen in the tread pattern.

**D. Casing**

- (1) The primary strength of a tyre is in its casing plies. A casing ply is a layer of high modulus cord which is coated with rubber compound to make a fabric. The fabric is assembled in layers (the casing plies) held together with layers of rubber compound.
- (2) For bias (cross-ply) aircraft tyres, the casing plies are installed around the bead coils to make the sidewalls of the tyre. This gives the bias tyre its strength. Adjacent layers of casing ply are put at opposite bias angles. The strength and load capacity of the tyre is related to the number of plies and bias angles.
- (3) In a tyre for a military application, the casing cord could be a red colour for easy visibility and indication of wear.

**E. Breakers**

- (1) A breaker is an added layer of fabric which gives more strength. The breaker layers are laid directly on the top casing ply across the width of the tread. They are a part of the tyre casing, and are not removed when the tyre is retreaded.

**F. Beads**

- (1) The tyre beads hold the tyre on its wheel. The beads are made of high tensile wire strands. Each wire strand is coated with rubber compound and is spiral-wound into a coil of the specified diameter for the tyre. A rubber component known as the apex is put on top of the bead coil to make the bead assembly.

- (2) The bead filler is a fabric component which helps to hold the bead coil assembly together. Also the filler gives more strength to the bead assembly, and more stiffness to the area of the tyre which is compressed with a high load against the wheel rim.

#### G. Chafers

- (1) A chafer component prevents chafing damage where the tyre is against the rim. It also decreases the conduction of brake heat to the tyre from the rim.
- (2) The chafer component is a strong nylon material which is coated with rubber. The chafer assembly is attached to the first ply and pulled around the bead face to the clinch area.

#### H. Sidewall

- (1) The sidewall is a layer of special rubber made with anti-oxidants. This rubber layer gives protection against weathering to the casing plies, and is resistant to contamination, cuts and flexing.

#### J. Inner Liner

- (1) The inner liner is a layer of special rubber compound around the inner face of a tubeless tyre. The inner liner is attached to the first casing ply (between one bead toe and the other) and is a seal which prevents leakage of inflation gas and moisture into the tyre casing.

#### K. Chined Tyres

- (1) Some types of nose wheel tyres include one (or two) chines moulded into the rubber at one of (or each of) the shoulder buttresses. A chine is a rubber extension (around the tyre circumference) that deflects water away from the engines during aircraft movement on a wet runway.

#### L. Breaker Package (Radial-Ply Tyres Only) (Ref. Fig. 4)

- (1) The breaker package (also known as the belt plies) is a number of plies (made of nylon or aramid) attached below the tread of a radial-ply tyre. The breaker package gives stiffness in the tread area, and helps to keep the circumference constant as the tyre expands when it is inflated.

#### M. Casing (Radial-Ply Tyres Only) (Ref. Fig. 4)

- (1) The casing of a radial-ply tyre is not the same as that in a bias (cross-ply) tyre. A ply of casing fabric for a radial-ply tyre is made of rubber coated cords as usual. But in a radial-ply tyre, the plies are laid so that the cord direction is from bead to bead (at approximately 90 degrees).



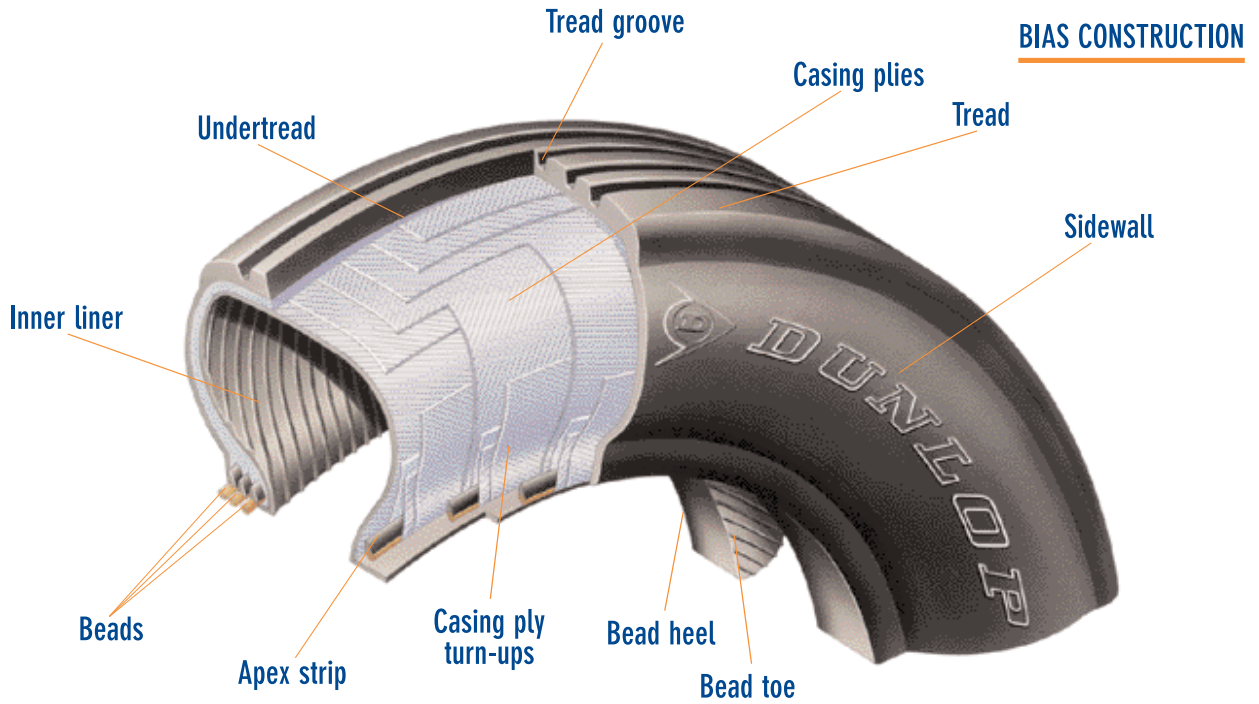

Bias (Cross-Ply) Tyre  
Figure 3

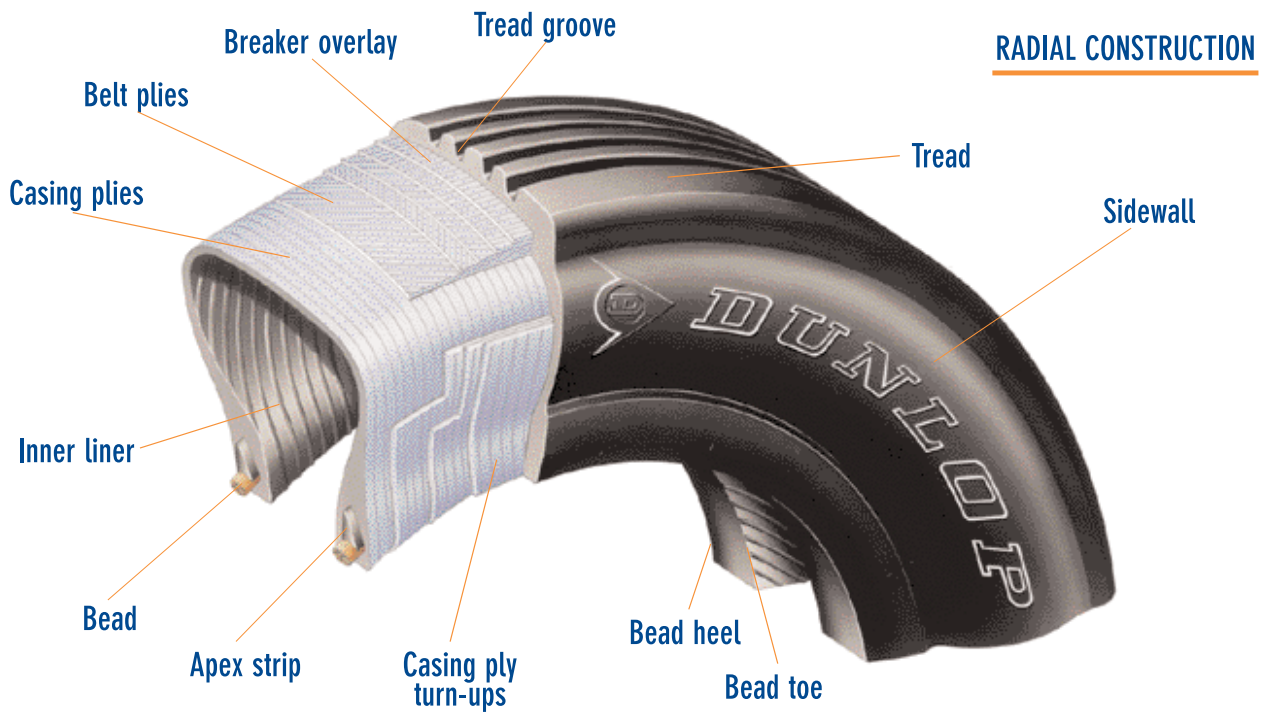

Radial-Ply Tyre  
Figure 4

RECEIVING INSTRUCTIONS AND STORAGE1. Introduction

- A. Aircraft tyres can be damaged accidentally during transport, or when they are received, or if they are kept in unsatisfactory conditions in a store. To keep the tyres serviceable, use the procedures in this Section (Page Block 100).

2. Instructions to Receive Tyres and Tubes

## A. Tyres

- (1) Examine the tyre for damage which could have occurred during transport. Tyres with only small damage (for example: cuts, scuffing, scratches or cracks not down to the cords) are serviceable. For a tyre to be serviceable, the damage must be less than that specified in Para. 4. of Maintenance Practices, Section Page Block 300.

**NOTE:** If you are not sure about the serviceability of a tyre, speak to a technical representative of DATL.

## B. Tubes

- (1) It is not necessary to examine a tube which is in packaging (unless the packaging is damaged). If the packaging is damaged, examine the tube as specified in Para. 9. of Maintenance Practices, Section Page Block 300.

3. Storage

## A. Storage Conditions

- (1) Keep tyres in a cool dry store which has protection against sunlight.
- (2) Do not keep tyres where they will be in air currents. Air currents contain increased levels of oxygen and ozone gas which can cause deterioration of rubber components.
- (3) Do not keep tyres near to electrical equipment (such as a generator or a motor) which could be a source of ozone gas. Ozone gas can cause deterioration of rubber components.
- (4) It is best to keep the temperature of the store between 0 and 32 deg. C (32 and 90 deg. F).
- (5) Keep the tyres away from hot pipes and radiators.
- (6) Do not keep tyres directly in sunlight or strong ultra-violet light. It is best to keep tyres in a storeroom without windows but with sodium vapour lights. If the storeroom has windows, it is best to paint the windows a dark colour and to cover the tyres with a sheet protection that does not transmit light.

**B. Storage Instructions****(1) Tyres**

- (a) Keep tyres vertical in an applicable rack. This will prevent tyre distortion. Tyres that have distortion are not easily installed.

**NOTE:** This is specially applicable to radial-ply tyres which have more flexible sidewalls than bias tyres.

- (b) Keep tyres away from contamination, such as oil, grease, hydraulic fluid or other solvents.

**(2) Tubes**

- (a) It is best to keep a tube in the packaging in which it was supplied.
- (b) Alternatively, inflate the tube to a low pressure while the tube is in a tyre of the correct size.
- (c) Keep tubes away from contamination such as oil, grease, hydraulic fluid or other solvents.

**C. Storage of Tyres Installed on Wheel Assemblies**

- (1) Do not keep installed tyres at high pressures for long times (more than 7 days). Ozone damage, groove splits and sidewall cracks occur more quickly in tyres kept at high pressure.
- (2) Decrease the pressure of an installed tyre which is to be kept in a store for more than 7 days, or if the tyre and wheel assembly is to be transported. Decrease the pressure to 25% of the operational pressure, or to a minimum of 2,75 bar (40 psi) if this is more than the 25% calculated pressure.

**D. Shelf Life**

- (1) Dunlop recommends that a tyre be kept in a store for no more than 12 years from its date of manufacture, if it is to stay serviceable. The storage conditions must be correct (Ref. Para. 3.A. thru 3.C.).
- (2) Do not use new tyres received in the store before you have used the other tyres of the same type. Find the dates when the tyres were made (as specified in the tyre serial numbers, Ref. Para. 2.F. of General Tyre Information, Section Page Block 1) to make sure that you use the new tyres last.
- (3) Tyres kept in the correct storage conditions (Ref. Para. 3.A. thru 3.C. above) for more than 12 years are to be used for one tread life only. Dunlop recommends that such tyres are not retreaded.
- (4) Tubes kept in the correct storage conditions (Ref. Para. 3.A. thru 3.C. above) for more than 12 years are to be used for one tyre life only.

INSTALLATION AND REMOVAL OF TYRES1. General

A. This Section (Page Block 200) includes instructions for tyre installation, inflation, deflation and removal. Use these instructions unless you have other special instructions.

2. Tyre Installation

## A. Installation of a Tubeless Tyre

- (1) Make sure that the tyre is the correct size for the wheel (Ref. Para. 2.B. of General Tyre Information, Section Page Block 1).
- (2) Make sure that the tyre specification (part number, ply rating, TSO rating, for example) is correct for the aircraft wheel.
- (3) Before you install the tyre, examine the tyre for damage and contamination. Make sure that the inner surface of the tyre is free from objects or contamination.
- (4) Examine the tyre for wear and damage (Ref. Para. 3. and 4. of Maintenance Practices, Section Page Block 300). If the wear or damage is less than the specified limits, send the tyre to be repaired or retreaded, as applicable. Discard the tyre if the wear or damage is such that the tyre cannot be repaired or retreaded.
- (5) Prepare the wheel assembly to install the tyre (Ref. the Component Maintenance Manual for the wheel) as follows:
  - (a) Make sure that the mating surfaces of the hubs are free from damage.
  - (b) Make sure that the inflation valve and the fuse plugs are in good condition and are tightened to their specified torques.
  - (c) Get a new O-ring seal of the correct size for the wheel. Lubricate the O-ring seal with the correct lubricant and install the seal.
- (6) Carefully apply a small quantity of an applicable bead lubricant (such as Red Turkey Oil) to the bead toe areas. The lubricant lets you install and remove the tyre more easily.

**CAUTION: MAKE SURE THAT YOU KEEP THE TYRE BEAD FACES FREE FROM GREASE. GREASE COULD CAUSE MOVEMENT BETWEEN THE TYRE AND THE WHEEL DURING BRAKING. THIS COULD CAUSE DAMAGE TO THE TYRE (AND THE TUBE, IF INSTALLED) AND THE BRAKING PERFORMANCE COULD BECOME UNSATISFACTORY.**

- (7) Make sure (unless you have other installation instructions), that you align the 'light' spot on the tyre (where there is a red triangle or spot) with the wheel valve, or with the wheel 'heavy' spot (which the wheel manufacturer shows on the wheel).

- (8) During installation of the tyre, make sure that you do not move the O-ring seal from its correct location.
- (9) If distortion of the tyre prevents a good seal against the wheel, apply a load (such as a tourniquet) to the tyre with the wheel vertical.

#### B. Installation of a Tubed Tyre

- (1) Before you install a tube, examine it for damage and contamination. Reject a tube which shows signs of cracking, or splitting at the bottom of the valve stem, or creasing (Ref. Para. 9. of Maintenance Practices, Section Page Block 300).
- (2) Apply French chalk or lubricating talc to the inner wall of the tyre. Shake the tyre to remove unwanted chalk or talc.
- (3) Align the 'heavy' spot on the tube (if there is a red stripe on the tube), or the tube valve stem with the 'light' spot on the tyre (where there is a red triangle or spot).
- (4) Carefully put the tube in the tyre. Use your fingers to make the tube smooth so that it is not creased or pinched. This will also make sure that air is not caught between the tube and the tyre.
- (5) Complete the assembly of the tyre to the wheel and install the bolts which hold the wheel half hubs together (Ref. the Component Maintenance Manual for the wheel).
- (6) Inflate, and then deflate the tube and tyre to remove air from between the tube and tyre. This also helps the tube to expand correctly so that it is not creased, or pinched in the toe of the bead.

### 3. Tyre Inflation

#### A. Initial Checks

- (1) Make sure that the wheel is assembled correctly (Ref. the Component Maintenance Manual for the wheel).
- (2) Make sure that you have an applicable safety cage so that you can inflate the tyre safely.
- (3) For pressures more than 7.0 bar (100 psi), make sure that you have an inflation connector which has a screw thread.
- (4) Make sure that the inflation gas is Nitrogen (or other inert gas) which contains less than 5% of oxygen (Ref. CAA Airworthiness Notice No. 70, 16 March 1988).
- (5) Make sure that there is a pressure-reducing valve in the gas supply line.
- (6) Make sure that there is a pressure regulator in the gas supply line, and that the regulator is calibrated correctly and regularly.
- (7) Make sure that the pressure gauge which you use to measure the tyre pressure is calibrated correctly and regularly.

**B. Inflation**

**WARNING:** WHEN YOU INFLATE THE TYRE, ALWAYS PUT THE TYRE AND WHEEL ASSEMBLY IN A SAFETY CAGE. TYRES AT HIGH PRESSURES CAN BE DANGEROUS.

- (1) Put the tyre and wheel assembly in a safety cage.
- (2) Put the gas supply line of the inflation equipment into the safety cage.
- (3) Attach the screw thread of the inflation connector to the inflation valve.
- (4) Initially, inflate the tyre slowly until the tyre beads are in their seats on the wheel.
- (5) Continue to inflate the tyre (and do pressure checks at the same time) until the tyre is at its specified operational pressure (Ref. the Aircraft Maintenance Manual).
- (6) Disconnect the gas supply line.
- (7) Use an applicable spray solution or a water immersion tank to examine the tyre and wheel assembly for gas leaks from:
  - The valve
  - The valve core
  - The fuse plugs
  - The mating area of the wheel half hubs
  - The bead seat areas.

**C. Checks for Loss of Pressure**

**NOTE:** New tyres can expand for up to 12 hours after inflation. This decreases the internal pressure. Also for up to 24 hours after inflation, diffusion of gas through the inner liner into the casing can occur. Subsequently, this diffusion decreases to a low constant level. The awl vent holes in the lower sidewall of the tyre release the diffused gas to the atmosphere, to prevent tyre damage.

- (1) Check pressure after a minimum of 12 hours after initial inflation with a calibrated pressure gauge. If necessary, re-inflate the tyre to its specified operational pressure (Ref. Para. 3.B.).
- (2) 24 hours or more after inflation, measure the pressure. The assembly should not lose more than 5% of the initial inflation pressure. Should pressure loss exceed 5% test the assembly by water check to find cause of leakage. If the cause is not found de-mount tyre (Ref. Para. 4.A.) and re-mount on a different wheel. Inflate tyre (Ref. Para. 3. B.), check for pressure loss (Ref. Para. 3. C.)
- (3) If pressure loss persists, remove tyre and return to Dunlop for investigation.

**NOTE:** The ambient air temperature has an effect on tyre pressure (Ref. Para. 2.F. of Maintenance Practices, Section Page Block 300).

**D. Diffusion from Awl Vent Holes**

- (1) Diffusion of gas from the awl vent holes (where there is green litho ink) is usual, and can occur at all times. Gas bubbles from the awl vent holes are seen during leakage checks when you use a water immersion tank or an applicable spray solution.
- (2) Do not reject a tyre only because there is diffusion of gas from its awl vent holes. The quantity of diffused gas is different for each tyre.

**4. Tyre Deflation and Removal****A. Tyre Deflation**

**WARNING:** USE THE CORRECT EYE PROTECTION WHEN YOU DEFLATE A TYRE. GAS FLOWS AT HIGH PRESSURES COULD SEND DUST OR DEBRIS INTO YOUR EYES.

- (1) Remove the valve cap.
- (2) Deflate the tyre (Ref. the Component Maintenance Manual for the wheel).

**WARNING:** MAKE SURE THAT THE TYRE IS FULLY DEFLATED. WHEN THE GAS FROM THE TYRE IS RELEASED, ICE CAN OCCUR IN THE VALVE AND CAUSE TEMPORARY BLOCKAGE.

- (3) Remove the valve core with the correct tool (Ref. the Component Maintenance Manual for the wheel).

**B. Tyre Removal**

- (1) Make sure that the tyre is fully deflated and that the valve core is removed (Ref. Para. 4.A.).

**CAUTION:** DO NOT USE TYRE LEVERS OR SHARP TOOLS TO MOVE THE TYRE BEADS OUT OF THEIR BEAD SEATS. YOU COULD CAUSE PERMANENT DAMAGE TO THE TYRE OR THE WHEEL, AND PREVENT A GOOD GAS SEAL.

- (2) Carefully move the tyre beads out of their bead seats in the wheel. If necessary, use an applicable bead breaking machine (Ref. the Component Maintenance Manual for the wheel).
- (3) Disassemble the wheel and remove the tyre (Ref. the Component Maintenance Manual for the wheel).
- (4) If the tyre is to be retreaded subsequently, keep it in an applicable store (Ref. Receiving Instructions and Storage, Section Page Block 100).



MAINTENANCE PRACTICES (FOR TYRES INSTALLED ON AIRCRAFT)1. General

- A. This Section (Page Block 300) contains the instructions necessary for the inspection and maintenance of tyres (and inner tubes) installed on aircraft. Use these instructions unless other instructions are specified in the Aircraft Maintenance Manual or in an Airworthiness Notice/Directive.
- B. The instructions in this Section are for ground crew and flight personnel to make sure that:
- (a) Tyres are safe for a flight.
  - (b) Unserviceable tyres with wear or damage more than specified limits are replaced.
  - (c) Worn tyres are removed at the correct time so that they can be retreaded satisfactorily.

2. Inflation Pressure Maintenance

- WARNINGS:
1. BE CAREFUL AT ALL TIMES WITH AIRCRAFT TYRES INFLATED TO HIGH PRESSURES. TYRES INFLATED TO HIGH PRESSURES CAN BE DANGEROUS.
  2. USE THE CORRECT HANDLING EQUIPMENT AND TOOLS FOR THE TYRES. MAKE SURE THAT EQUIPMENT IS CALIBRATED ACCURATELY AND REGULARLY.
  3. ALWAYS USE THE CORRECT EYE PROTECTION WHEN YOU INFLATE OR DEFLATE TYRES.
  4. DO NOT INFLATE TYRES DIRECTLY FROM A HIGH PRESSURE BOTTLE. ALWAYS MAKE SURE THAT A PRESSURE REDUCING VALVE IS USED TO DECREASE PRESSURE INITIALLY, AND THAT A PRESSURE REGULATOR VALVE IS USED TO CONTROL PRESSURE.

## A. Inflation Pressure Checks

- (1) Tyres on aircraft must be kept at the correct operational pressure. An increase or decrease in pressure from the correct specified operational value can cause deterioration of a tyre, and have an effect on the life and safety of the tyre.
- (2) An under inflated tyre (in which the pressure is too low) has an increased deflection, and becomes hotter during aircraft movement on the ground. Increase of heat in the carcass can cause separation of the plies, tread separation, and possibly tyre failure.
- (3) An over inflated tyre (in which the pressure is too high) wears more quickly on the crown of the tread, and can be damaged more easily.
- (4) Measure tyre pressures regularly, at least each 24 hours, or before each flight.

**WARNING:** DO NOT USE TYRE DEFLECTION TO MEASURE TYRE PRESSURE. ALWAYS USE A PRESSURE GAUGE WHICH IS ACCURATELY CALIBRATED. INCORRECT TYRE PRESSURES CAN INCREASE THE RATE OF WEAR, CAUSE MORE HEAT AND DECREASE THE TYRE LIFE. FAILURES SUCH AS COMPONENT SEPARATION CAN OCCUR QUICKLY IN TYRES WITH INCORRECT PRESSURES. TYRE FAILURES CAN BE DANGEROUS TO PERSONNEL AND COULD CAUSE DAMAGE TO THE AIRCRAFT.

- (5) Do not use tyre deflection to measure tyre pressure. For example, a tyre on a strut with two wheels could be under inflated (have a pressure which is too low). But its deflection will look the same as the other tyre which has the correct pressure. This is because the tyre with the correct pressure has an increased load.

#### B. Pressure Checks at Ambient Temperature

- (1) Measure tyre pressures (and adjust tyre pressures) while the tyres are at ambient temperature.
- (2) After an aircraft landing, let the tyres cool to ambient temperature for approximately three hours. Then you can measure the tyre pressures correctly.

#### C. Inflation Pressures

- (1) The usual diffusion of gas through the inner liner of a tyre decreases the tyre pressure. A pressure decrease of 5% of the operational pressure in 24 hours can be accepted.
- (2) Before each flight (or each day), make sure that the pressures of the tyres are in the operational pressure range (as specified in the Aircraft Maintenance Manual). When you measure tyre pressure, use a pressure gauge which is accurately and regularly calibrated.
- (3) Tyre pressures must be as specified in the Aircraft Maintenance Manual. The specified pressures are related to the gross weight of the aircraft and the centre of gravity of the aircraft.
- (4) Tyre deflection increases the pressure in a tyre. A tyre with the aircraft weight on it has a pressure which is 4% higher (1.04 x higher) than a tyre without the aircraft weight on it. When you measure tyre pressure, make sure that you have the correct specified value of the tyre pressure (the pressure with the aircraft weight on or off the tyre, as applicable).
- (5) Table 301 shows the maintenance tolerances recommended for tyre pressures. Always refer to the Aircraft Maintenance Manual for the correct tyre pressures.

TABLE 301 RECOMMENDED TYRE PRESSURE TOLERANCES

Tyre Pressure Range		Tolerance	
(bar)	(psi)	(bar)	(psi)
0 to 3.4	0 to 49	+0.3/-0	+4/-0
3.5 to 6.8	50 to 99	+0.4/-0	+6/-0
7.0 to 13.7	100 to 199	+0.7/-0	+10/-0
13.8 and higher	200 and higher	+1.0/-0	+15/-0

**D. Recommended Tyre Pressure Maintenance**

- (1) Table 302 shows different measured pressure ranges as a percentage of operational pressure. For each pressure range the table gives the tyre status and the pressure adjustment which is necessary.
- (2) The pressure values and adjustments in Table 302 are only applicable to tyres which are at ambient temperature.
- (3) Make sure that you use the correct operational pressure value (Ref. the Aircraft Maintenance Manual).

**NOTE:** The pressure value for a tyre on the aircraft (with the aircraft weight on the tyre) is 1.04 x the pressure value for a tyre off the aircraft (without the aircraft weight on the tyre).

TABLE 302 RECOMMENDED TYRE PRESSURE MAINTENANCE

Measured Pressure Range (% of Operational Pressure)	Tyre Status	Maintenance
More than 105%	Over inflated (pressure too high)	Decrease the pressure to the maximum of the operational pressure range
From 105% to 100%	Pressure in usual operational range	None
From 100% to 95%	Pressure decrease which can be permitted each day	Increase the pressure to the maximum of the operational pressure range

TABLE 302 RECOMMENDED TYRE PRESSURE MAINTENANCE (continued)

Measured Pressure Range (% of Operational Pressure)	Tyre Status	Maintenance
From 95% to 90%	Under inflated (pressure has decreased accidentally to limits which are less than those permitted for pressure decrease each day)	<ol style="list-style-type: none"><li>1. Increase the pressure to the maximum of the operational pressure range.</li><li>2. Record the tyre status and the pressure adjustment in the Service Logbook.</li><li>3. Do a pressure check after 24 hours. If the pressure has decreased more than 5%, remove the wheel assembly from the aircraft to find the cause.</li></ol>
From 90% to 80%	Under inflated (pressure has decreased to limits which are less than those permitted for accidental pressure decrease)	<ol style="list-style-type: none"><li>1. Remove the wheel from the aircraft.</li><li>2. Inflate the tyre to its specified operating pressure.</li><li>3. Do a pressure check after 24 hours. If the pressure has decreased more than 5%, find the cause.</li><li>4. If you cannot find and correct the cause of the pressure decrease, replace the tyre. Send the removed tyre for more checks, and repair if necessary.</li></ol>
From 80% to 0% (see Note below)	Flat tyre (pressure has decreased too quickly)	<ol style="list-style-type: none"><li>1. Remove the wheel assembly and, if applicable, remove the wheel assembly on the same strut.</li><li>2. Replace the tyre(s).</li></ol>

**NOTE:** You could find that one or more of the fuse plugs are blown in a wheel. If a wheel fuse plug has blown and the aircraft has moved on the ground, the tyre (and the tyre(s) for the wheel(s) on the same strut) will be permanently damaged. Replace the tyre(s). If a wheel fuse plug has blown and the aircraft has not moved on the ground, the tyre(s) could be serviceable.

**E. Pressure Maintenance of Hot Tyres**

- (1) Movement of the aircraft on the ground causes heat in the tyres. Also tyres can receive heat transmitted through the wheel from hot brakes, or from the aircraft structure. The tyres on an aircraft can be at different temperatures related to the different quantities of heat transmitted.

**WARNING:** DO NOT DECREASE THE PRESSURES OF HOT TYRES, BECAUSE AT AMBIENT TEMPERATURE, THEIR PRESSURES WILL BE LESS THAN THE CORRECT OPERATIONAL PRESSURE.

- (2) Let hot tyres become cool at ambient temperature before you do a check of tyre pressures.

**NOTE:** The time necessary for a tyre to become cool at ambient temperature can be up to three hours after a landing (and is related to the tyre size).

- (3) In special operational conditions, it could be necessary to do a tyre pressure check while the tyres are hot. If so, use these instructions:

**NOTE:** You can use a temperature compensated pressure gauge to do pressure checks of hot tyres. The subsequent instructions (a), (b) and (c) are not then necessary.

- (a) For a landing gear strut with one wheel, the tyre pressure must be at (or more than) the specified operational pressure.
- (b) For a landing gear strut with two wheels, with the two tyres at approximately the same temperature, the pressures must be equal. If not, inflate the tyre with the lowest pressure so that its pressure is the same as that of the tyre with the highest pressure. Record (in the Service Logbook) the pressures of the tyres before and after the pressure check, and the ambient temperature. If at the subsequent pressure check, the pressure is lower in the tyre which you inflated, replace the tyre if the pressure decrease is more than specified limits (Ref. Table 302).
- (c) The pressures of tyres on a strut with a multi-bogie landing gear must be in the limits of +/- 5% of the highest pressure (if all the tyres are at approximately the same temperature). Inflate a tyre which has a pressure which is too low until its pressure is in the correct limits. Record (in the Service Logbook) the inflation pressures of the tyres before and after the pressure check, and the ambient temperature. If at the subsequent check, the pressure is lower in the same tyre(s) which you inflated, replace the tyre if the pressure decrease is more than specified limits (Ref. Table 302).

**F. Pressure Maintenance with Changes of Ambient Temperature**

- (1) An increase in ambient temperature of 3 deg. C causes an increase of 1% in tyre pressure. A decrease in ambient temperature of 3 deg. C causes a decrease of 1% in tyre pressure. If the change in ambient temperature is more than 25 deg. C (as can occur for flights between different climates) you must inflate the tyre to the correct pressure before the start of the flight.

- (2) For a flight from a cold to a hot climate, inflate the tyre to its usual operational pressure in the cold climate before a take-off. For an ambient temperature increase of 35 deg. C (for example), the calculated pressure increase is  $35 \div 3 = 11.6\%$ . In the hot climate, the increased pressure will be safe for a landing and a take-off.
- (3) For a flight from a hot climate to a cold climate you must increase the tyre pressure in the hot climate (to a calculated value) before a take-off. For an ambient temperature decrease of 35 deg. C (for example), the calculated pressure decrease is  $35 \div 3 = 11.6\%$ . Thus an increase in tyre pressure of 11.6% is necessary in the hot climate before a take-off. The decreased pressure in the cold climate will then be safe for a landing and take-off.

### 3. Tyre Inspection (Wear Limits)

#### A. Introduction

- (1) You must examine tyres installed on an aircraft regularly for wear as a part of routine maintenance. Replace a tyre which is worn more than the limits specified (Ref. Para. 3.B. thru G.). A tyre which is worn less than the limits specified is serviceable (unless damage to the tyre is more than specified limits, Ref. Para. 4.B. thru L.).

#### B. Retreadable Tyre

- (1) Replace a retreadable tyre when it is worn to these limits:
  - (a) The first time the wear (where the wear occurs most quickly) is down to the bottom of a groove at a point on the tread circumference, or
  - (b) The first time the fabric can be seen at a point on the tread circumference (although the remaining tread is satisfactory).

**NOTE:** Usually a tyre is not retreaded if it is worn more than the above limits.

#### C. Non-Retreadable Tyre

- (1) Remove and discard a non-retreadable tyre if it is worn to these limits:
  - (a) For a bias (cross-ply) tyre, the first time the casing ply can be seen (at the location where the wear occurs most quickly).
  - (b) For a radial-ply tyre, the first time the nylon belt can be seen (at the location where the wear occurs most quickly).

**D. Tyre with Nylon Fabric Included**

- (1) In some types of high speed tyre, the tread can include Nylon fabric to give more strength. This fabric shows in the tread pattern as the tyre wears during the life of the tread.
- (2) Replace a tyre with nylon fabric included when it is worn as specified in Para. 3.B. or 3.C., as applicable.

**E. Tyre in Very Wet Operational Conditions**

- (1) Very wet operational conditions could cause aquaplaning during a landing. For such conditions, replace a tyre the first time that the wear shows a groove depth of less than 2 mm (0.08 in.) at a point on the tread circumference.

**F. Multi-dimple Tyre**

- (1) Replace a multi-dimple tyre the first time the tread in a row of dimples is worn to the bottom of the dimples.

**G. Twin-contact Tyre**

- (1) Replace a twin-contact tyre the first time the centre of the crown shows signs (roughness or marks) that it has touched the ground.

**4. Tyre Inspection (Damage Limits and Tyre Failures)****A. Introduction**

- (1) You must examine tyres installed on an aircraft regularly for damage and failures as a part of routine maintenance. Replace a tyre which has a failure, or is damaged more than the limits specified (Ref. Para. 4.B. thru P.).

**NOTE:** A tyre which is damaged less than the limits specified in Para. 4.B. thru P. is serviceable (unless the tyre wear is more than specified limits, Ref. Para. 3.B. thru G.).

**B. Chevron Cutting (Ref. Fig 301)**

- (1) Chevron cutting can occur when there is wheel spin-up during a landing on a runway which has cross groove cuts. Replace a tyre with chevron cutting if:
  - (a) You can see more than 7 cm<sup>2</sup> (1.0 in.<sup>2</sup>) of fabric, or
  - (b) The area of the chevron cutting is more than the tread footprint, or

- (c) The chevron cutting extends below a tread rib.



Chevron Cutting  
Figure 301

C. Tread Chunking (Ref. Fig. 302)

- (1) A tight aircraft turn, or an aircraft taxied quickly, or operation on rough runways can cause tread chunking. Replace a tyre with tread chunking if:
- (a) You can see more than 7 cm<sup>2</sup> (1.0 in.<sup>2</sup>) of tread chunking on a tread rib, or
  - (b) You can see more than 7 cm<sup>2</sup> (1.0 in.<sup>2</sup>) of fabric, or
  - (c) The tread chunking extends below a tread rib.



Tread Chunking  
Figure 302

D. Cut Damage (Ref. Fig. 303)

**WARNING:** IMMEDIATELY REPLACE A TYRE WHICH HAS CUTS MORE THAN THE LIMITS SPECIFIED BELOW. CUTS CAN CAUSE THE SEPARATION OF A TREAD RIB.

**NOTE:** Some very high speed tyres have nylon fabric reinforcement in the ribs of the tread. You will see this fabric as the tread wears. Cuts in this fabric are not necessarily a cause for tyre replacement (unless the cuts are more than the limits specified below).



- (1) Debris on the runway can cause cuts to the tread and the sidewall of a tyre. Replace a tyre with cuts if:
  - (a) The cuts are into the casing plies, or
  - (b) The cuts have a depth in the tread of 50 % or more of the tread depth at that time, or
  - (c) The cuts extend across more than 35 mm (1.4 in.) or 50 % of a tread rib, or
  - (d) You can see the casing cords, for example when you open the cut.
- (2) Before retreading, it is possible to repair some tyres with small cuts in the casing plies. Send a tyre that has small cuts in the casing plies to the Supplier for inspection and possible repair.



Cut Damage  
Figure 303

E. Dry Braking Flats (Ref. Fig. 304)

- (1) Locked (or almost locked) wheels during a landing on a dry runway can cause a dry braking flat spot on a tyre. This is a flat scuffed surface on a part of the tread circumference.
- (2) Replace the tyre that has a dry braking flat spot if the wear is more than the specified wear limits (Ref. Para. 3.).
- (3) Replace the tyre if the dry braking flat spot causes out-of-balance or shimmy movements of its wheel.



Dry Braking Flats  
Figure 304

F. Wet Braking Flats (Ref. Fig. 305)

- (1) Hydroplaning during a landing on a wet runway can cause a wet braking flat spot on a tyre. This has a surface that looks almost the same as melted rubber.
- (2) Replace a tyre that has a wet braking flat spot if the wear is more than the specified wear limits (Ref. Para. 3).
- (3) Replace the tyre if the wet braking flat spot causes out-of-balance or shimmy movements of its wheel.



Wet Braking Flats  
Figure 305

G. Bulges (Tyre Failure) (Ref. Fig. 306)

- (1) A bulge in the tread or sidewall can occur if there is a separation of tyre components (for example, because the tyre was too hot). A tyre bulge could occur if an aircraft is taxied quickly over a long distance.

**WARNING:** IMMEDIATELY REPLACE A TYRE WHICH SHOWS A BULGE. A TYRE WHICH SHOWS A BULGE IN THE TREAD OR SIDEWALL COULD HAVE CASING SEPARATION.

- (2) Immediately identify the position of the bulge with a crayon mark and replace the tyre.

- (3) Send the tyre to the supplier for inspection.



Bulge  
Figure 306

H. Shoulder Wear (Ref. Fig. 307)

- (1) Wear more than specified limits on a shoulder of the tyre is usually related to operation with low tyre pressures. Low tyre pressures cause more deflection of the tyre sidewalls. Also, the increased deflection causes more heat in the tyre, the result of which could be component separation and possibly a tyre burst.
- (2) Replace a tyre with shoulder wear if:
  - (a) It is found to be under inflated - the pressure has decreased to limits less than those permitted each day (Ref. Table 302), or
  - (b) The tyre wear is more than the specified wear limits (Ref. Para. 3.).



Shoulder Wear  
Figure 307

J. Burst (Tyre Failure) (Ref. Fig. 308)

- (1) The causes of a tyre burst could be:
  - (a) Debris on the runway.

- (b) Operation with low tyre pressures, or the aircraft is taxied quickly for a long time. These operations can cause impact concussion or increase the rate of fatigue in the carcass.
- (2) A tyre burst increases the load on the other tyre(s) on the same strut. The carcass(es) of the tyre(s) which receive the added load could be damaged. The burst tyre and its related tyre on the same axle must be removed and discarded if the aircraft has moved on the ground with a burst tyre.



Burst (Tyre Failure)  
Figure 308

K. Lateral Scoring (Ref. Fig. 309)

- (1) A landing in a high cross wind can cause lateral scoring across the tread of a tyre. Tight aircraft turns can cause lateral scoring on the shoulders of the tread.
- (2) With large lateral scoring damage, adjacent tears can also occur in the interface between the tread and the casing. Subsequently, during the life of the tyre, the tears can be related to separation of tyre components.
- (3) Replace a tyre if the scoring has related tread chunking more than specified limits (Ref. Para. 4.C.) or cuts below a rib.



Lateral Scoring  
Figure 309

L. Sidewall Cracking (Ref. Fig. 310)

- (1) Large tyre deflection, or weathering can cause cracks in the sidewall of a tyre. Sidewall cracks can also occur in a tyre which is kept in unsatisfactory storage conditions.
- (2) Replace a tyre with sidewall cracking if you can see fabric cords through the sidewall cracking.



Sidewall Cracking  
Figure 310

M. Tread Groove Cracking (Ref. Fig. 311)

- (1) Tread groove cracking is related to high stresses in the tyre. For example, high stresses are caused during aircraft movements with the tyre under inflated (pressure too low). Contamination (fuel or grease on the tyre) can also cause tread groove cracking.
- (2) Replace a tyre with tread groove cracking if:
  - (a) You can see fabric cords through the cracking, or
  - (b) The groove cracking extends to undercuts below a tread rib.

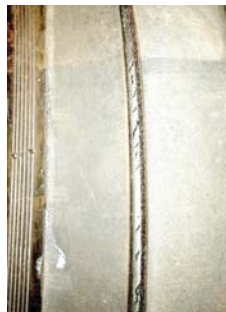

Tread Groove Cracking  
Figure 311

N. High Brake Heat (Ref. Fig. 312)

- (1) Heat from the brakes can be transmitted through the wheel to the bead areas of the tyre. A high braking force can increase the heat transmitted which then causes damage to the tyre.
- (2) Examine the tyre in the area adjacent to the wheel rim for signs of heat damage. Replace the tyre if:
  - (a) There are blisters on the bead rubber, or
  - (b) There are large blue or brittle areas of bead rubber, or
  - (c) The rubber in the bead area has melted.



High Brake Heat  
Figure 312

P. Open Tread Joint (Ref. Fig. 313)

- (1) Replace a tyre with an open tread joint or splice (Ref. the witness mark shown on Fig. 313) if:
  - (a) The open tread splice is more than 3 mm (0.12 in.) at the tread surface (at a point around the circumference of the tyre), or
  - (b) The depth of an open splice is more than 1 mm (0.04 in.) at a point on the tread.



Open Tread Joint  
Figure 313

5. Procedure After a Rejected Take-Off (RTO)

- A. There are different levels of RTO related to aircraft speeds, loads and distances. For some levels of RTO the aircraft tyres can become unserviceable. For other levels of RTO it is not necessary to replace the tyres.
- B. Replace the tyres after an RTO if:
  - (1) The aircraft speed during the RTO was more than its usual landing speed, and
  - (2) The braking energies used were usually high.
  - (3) The fuse plugs in the wheel were blown.
- C. Send tyres removed after an RTO for inspection and repair.
- D. After an RTO for which the tyres stay serviceable, it is recommended that you let the tyres become cool for a minimum of 30 minutes. And then continue the usual aircraft operations.

6. Flat Spots

- A. If an aircraft does not move for a time its tyres can get temporary flat spots as the tyre fabric sets. The effect can be worse during cold weather. Flat spots are usually removed when the aircraft is taxied.
- B. If the aircraft is to be kept in a store for a long time you must be careful to prevent flat spots on the tyres. Lift the aircraft with jacks so that the wheels are off the ground. Or, move the aircraft regularly.
- C. Replace tyres with flat spots if they cause too much aircraft vibration. Send the removed tyres for inspection and repair.

7. Contamination

- A. Contamination of tyres with hydraulic fluid, fuel, oil or grease can cause deterioration of the rubber.
- B. Remove tyre contamination as quickly as possible. Use denatured alcohol, or detergent and clean water.

8. Uneven Wear

- A. The geometry of some aircraft is such that the tyres wear more on one side of the tread. Some tyres with this type of wear can be removed, turned around and installed again, if the wear is not more than specified limits (Ref. Para. 3.). If you are not sure about this procedure, speak to a technical representative of the aircraft manufacturer or of DATL.
- B. An over inflated tyre can wear more in the centre of its tread. To prevent this type of wear, inflate the tyre to its correct pressure (Ref. the Aircraft Maintenance Manual).

9. Tube Inspection (Damage Limits)

A. Tube Chafing (Related to Tyre Creep) (Ref. Fig. 314)

- (1) Creep (movement of the tyre in relation to the wheel) can cause chafing of the tube against the toes of the tyre, or it can cause damage to the valve.
- (2) Examine the creep marks painted on the tyre and wheel. If the creep is more than 25 mm (1.0 in.), replace the tube.

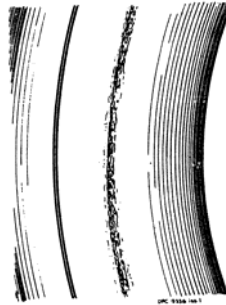

Tube Chafing  
Figure 314

B. Tube Creasing (Ref. Fig. 315)

- (1) Incorrect installation can cause creasing of a tube. Tube creasing can also occur when pressure is decreased after a tube and tyre have been over inflated.
- (2) Replace a tube which shows signs of creasing.





Tube Creasing  
Figure 315

C. Tube Cracking (Ref. Fig. 316)

- (1) To examine a tube for cracking, hold the rubber between your thumb and finger and apply pressure. Replace a tube with cracking if the cracking is more than on the surface (the cracking extends into the rubber of the tube).

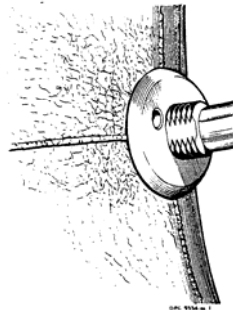

Tube Cracking  
Figure 316

